

Ролка Estebro® за плъзгащи се врати с втулка ф 120x10 мм, стоманена, U-10

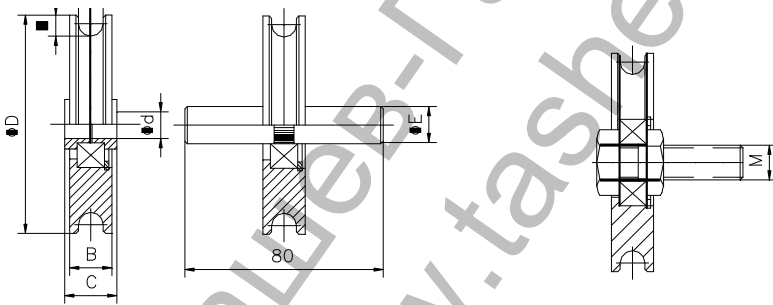

Cod	Dimens.	ØD	A	B	C	Ød	ØE	M			Peso Max. Kg
100	45x10	45	8	16	.	10	.	30	4,30	196	
101	60x10	58	8	17	22	12	15	14x50	30	6,30	375
102	70x10	68	9	17	22	12	15	14x50	24	7,45	375
103	80x10	78	9	17	22	12	15	14x50	15	6,75	375
104	90x10	88	9	17	22	12	15	14x50	12	7,30	375
105	100x10	98	9	17	22	12	15	14x50	12	9,35	375
106	120x10	118	9	17	22	12	15	14x50	7	8,40	375
111	150x10	147	9	19	32	16	20	16x50	4	8,65	655
116	180x10	177	9	19	32	16	20	16x50	4	13,04	655
112	200x10	197	9	19	32	16	20	16x50	4	16,35	655
143	250x10	247	9	19	32	16	20	16x50	3	20,00	655

Family: Wheels

Material: 11SMn30 steel

Finish: Zinc-plated

Maximum weight supported by the bearing*: See table **Description:** Wheel with bearing 6202 2RS. It is normally installed on overhead doors to allow the displacement of the cable. It can be supplied with reducing sleeves to 12 mm, with an axle of Ø 15 mm and 80 mm long, or with a M.14x50 screw.

***In perfect conditions of installation, usage and maintenance.**

Продукт: [Ролка Estebro® за плъзгаци се врати с втулка ф 120x10 мм, стоманена, U-10](#)

Категория: [Плъзгаци се врати](#)

Бранд: [Estebro®](#)

Категория бранд: [Ролка Estebro®](#)

Ташев-Галвинг ООД
www.tashev-galving.com